

FITINOX S.R.L.



Ingeniería en accesorios para instrumentación y piping

Industria Argentina, con calidad que se exporta.

ACCESORIOS FORJADOS

SERIES 2000, 3000, 6000 y 9000 LIBRAS

Roscados y Socket-Weld



GENERALIDADES

Los accesorios forjados se fabrican en acero al carbono según norma ASTM A105 y acero inoxidable en las calidades AISI 304/L y 316/L, según Norma ASTM A182, y para los accesorios rectos fabricados de barra laminada, según la norma ASTM A479/M.

El acabado superficial puede ser Decapado, Decapado y pasivado o cincado electrolítico, para los accesorios de acero carbono exclusivamente.

Las dimensiones y tolerancias están en un todo de acuerdo

con las normas MSS-SP-49.50 y ANSI B16.11.

Los accesorios de la serie 2000, 3000, 6000 y 9000 pueden ser de tipo Socket-Weld (para soldar a enchufe) o de tipo roscados NPT. También se pueden fabricar con Roscas BSP y BSPT a pedido.

Tanto las roscas como los socket son exhaustivamente calibrados a fin de proporcionar perfectas uniones al momento de la instalación.

www.fittinox.com.ar



ACCESORIOS PARA SOLDAR A ENCHUFE

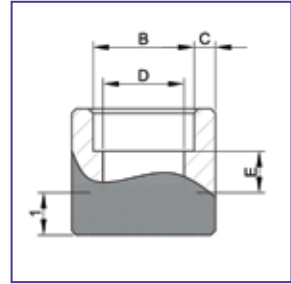
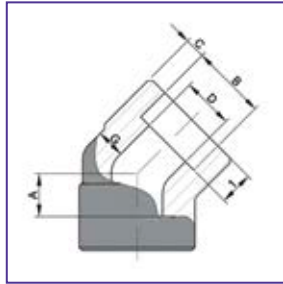
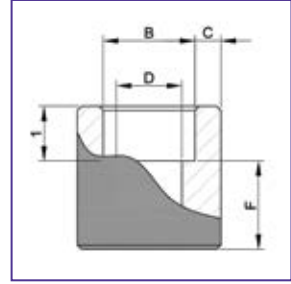
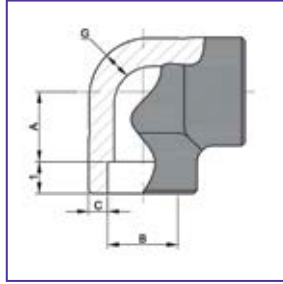
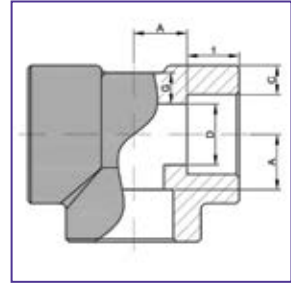
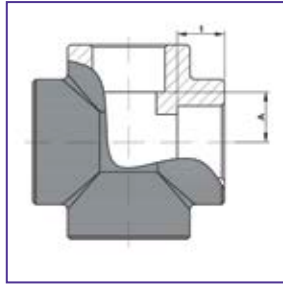

Diámetro nominal	Diámetro del enchufe (Día. Min y Max)	Diámetro interior del accesorio (2) D			Espesor de pared del enchufe (C)						Espesor de pared del accesorio (G)			Profundidad del enchufe Min. (J)	Centro al tope del enchufe (A)						Distancia entre Topes			
					Serie / Lbs						Serie / Lbs				Codo 90°, Te y Cruz			Codos 45°			Cupla (E)	Media Cupla (F)		
		Serie / Lbs			3000		6000		9000		3000 6000 9000				Serie / Lbs			Serie / Lbs						
		3000	6000	9000	Prom.	Min	Prom.	Min	Prom.	Min	Min.	Min.	Min.		3000	6000	9000	3000	6000	9000				
1/8"	10,90	7,6	4,8		3,2	3,2	3,95	3,45				2,4	3,15		10	12	12		9	9		8	17	
	10,65	6,1	3,2													10	10		7	7		5	15	
1/4"	14,35	10	7,1		3,8	3,3	4,6	4				3	3,7		10	12	17		9	9		8	17	
	14,10	8,5	5,6													10	13		7	7		5	15	
3/8"	17,80	13,3	9,9		4	3,5	5,05	4,35				3,2	4		10	15	17		9	13		9	19	
	17,55	11,8	8,4													12	14		6	10		3	16	
1/2"	21,95	16,6	12,5	7,2	4,65	4,1	5,95	5,2	9,35	8,2	3,75	4,8	7,45	10	17	21	27		13	14	17	13	24	
	21,70	15	11	5,6											14	18	24		10	11	14	6	21	
3/4"	27,30	21,7	16,3	11,8	4,9	4,25	6,95	6,05	9,8	8,55	3,9	5,55	7,8	13	21	24	30		14	16	21	13	25	
	27,05	20,2	14,8	10,3											18	21	27		11	13	17	6	22	
1"	34,05	27,4	21,5	16	5,7	5	7,9	6,95	11,4	9,95	4,55	6,35	9,1	13	24	29	34		16	19	23	17	31	
	33,80	25,9	19,9	14,5											20	25	30		12	16	19	9	27	
1 1/4"	42,80	35,8	30,2	23,5	6,05	5,3	7,9	6,95	12,5	10,6	4,85	6,35	9,7	13	29	34	37		19	23	24	17	32	
	42,55	34,3	28,7	22											25	30	33		16	19	20	9	28	
1 1/2"	48,90	41,7	34,7	28,7	6,35	5,55	8,9	7,8	12,7	11,15	5,1	7,15	10,15	13	24	40	40		23	27	28	17	34	
	48,65	40,1	33,2	27,2											30	36	36		19	23	23	9	30	
2"	61,35	53,5	43,6	38,9	6,95	6,05	10,9	9,5	13,85	12,15	5,55	8,75	11,05	16	40	43	56		27	31	31	23	43	
	61,10	51,7	42,1	37,4											36	39	52		23	27	26	15	39	
2 1/2"	74,20	64,2			8,75	7,65					7			16	44				31				24	45
	73,80	61,2													39				27				14	40
3"	90,15	79,5			9,5	8,3					7,6			16	60				34				24	47
	89,80	76,4													55				29				14	42
4"	115,80	103,8			10,7	9,35					8,55			16	69				44				24	50
	115,45	100,7													64				38				14	45

Dimensiones en milímetros (mm)

UNIONES DOBLE SOCKET WELD

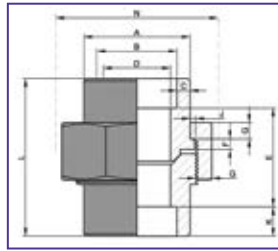

Diam Nominal	A (min.)	B	C (min)	D	E	F (min.)	G	J (min)	K (min)	L	N
1/8"	21,8	10,92	3,17	6,83	22,4	3,17	3,17	1,24	9,6	41,4	49
		10,67		6,43	19						
1/4"	21,8	14,22	3,3	9,85	22,4	3,17	3,17	1,24	9,6	41,4	49
		13,97		9,45	19						
3/8"	25,9	17,78	3,48	13,92	26,9	3,43	3,43	1,37	9,6	46	55
		17,53		13,51	20,6						
1/2"	31,2	21,84	4,06	17,47	26,9	3,68	3,68	1,5	9,6	49	57
		21,59		17,07	20,6						
3/4"	37,1	27,18	4,27	21,79	31,8	4,06	4,06	1,68	12,7	56,9	67
		26,92		21,39	25,4						
1"	45,5	34,04	4,95	28,14	34,3	4,57	4,44	1,85	12,7	62	79
		33,78		27,74	26,2						
1 1/4"	54,9	42,67	5,28	35,76	40,6	5,33	5,21	2,13	12,7	71,1	94
		42,42		35,36	32,5						
1 1/2"	61,5	48,77	5,54	41,61	42,2	5,84	5,59	2,31	12,7	76,5	111
		48,51		41,2	34						
2"	75,2	61,47	6,05	52,53	45,5	6,6	6,35	2,69	15,8	86,1	132
		61,21		52,12	37,3						
2 1/2"	91,7	74,17	7,65	64,72	61,7	7,49	7,11	3,07	15,8	102,4	148
		73,66		64,31	52,1						
3"	109,2	90,17	8,31	77,67	63,8	8,25	8	3,53	15,8	109	175
		89,66		77,27	53,6						

Dimensiones en milímetros (mm)

UNIONES DOBLE ROSCADAS

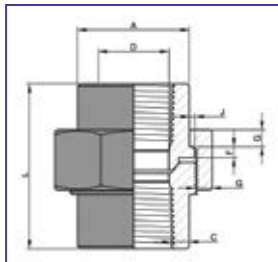

Diam Nominal	A (min.)	C (min)	D	F (min.)	G	J (min)	L	N
1/8"	14,70	2,41	6,83	3,17	3,17	1,24	41,4	49
			6,43					
1/4"	19,00	3,02	9,85	3,17	3,17	1,24	41,4	49
			9,45					
3/8"	22,90	3,20	13,92	3,43	3,43	1,37	46,0	55
			13,51					
1/2"	27,70	3,73	17,47	3,68	3,68	1,50	49,0	57
			17,07					
3/4"	33,50	3,91	21,79	4,06	4,06	1,68	56,9	67
			21,39					
1"	41,40	4,55	28,14	4,57	4,44	1,85	62,0	79
			27,74					
1 1/4"	50,50	4,85	35,76	5,33	5,21	2,13	71,1	94
			35,36					
1 1/2"	57,20	5,08	41,61	5,84	5,59	2,31	76,5	111
			41,20					
2"	70,10	5,54	52,53	6,60	6,35	2,69	86,1	132
			52,12					
2 1/2"	85,30	7,01	64,72	7,49	7,10	3,07	102,4	148
			64,31					
3"	102,40	7,62	77,67	8,25	8,00	3,53	109,0	175
			77,27					

Dimensiones en milímetros (mm)

ACCESORIOS ROSCADOS

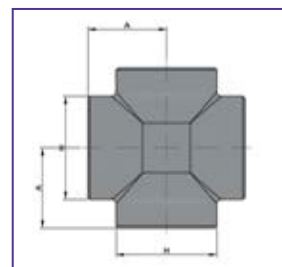
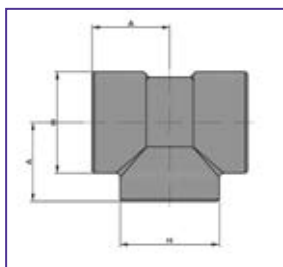
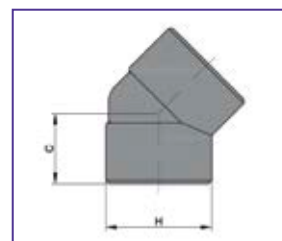
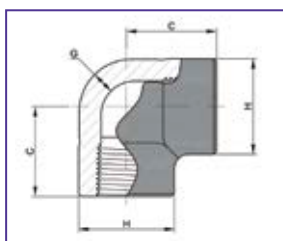

Diam Nominal	Codo 90° - Te - Cruz (A)			Codo 45° (C)			(H)			(G) Min.		
	2000	3000	6000	2000	3000	6000	2000	3000	6000	2000	3000	6000
1/8"	21	21	25	17	17	19	22	22	25	3	3	6,5
1/4"	21	25	29	17	19	22	22	25	33	3	3,5	6,5
3/8"	25	29	33	19	22	25	25	33	38	3	3,5	7
1/2"	29	33	38	22	25	29	33	38	46	3	4	8
3/4"	33	38	44	25	29	33	38	46	56	3	4,5	8,5
1"	38	44	51	29	33	35	46	56	62	3,5	5	10
1 1/4"	44	51	60	33	35	43	56	62	75	4	5,5	10,5
1 1/2"	51	60	64	35	43	44	62	75	84	4	5,5	11
2"	60	64	83	43	45	52	75	84	102	4,5	7	12
2 1/2"	76	83	95	52	52	64	92	102	121	5,5	7,5	15,5
3"	86	95	106	64	64	79	110	121	146	6	9	16,5
4"	106	114	114	79	79	79	146	152	152	6,5	11	18,5

Dimensiones en milímetros (mm)

CUPLAS Y TAPAS ROSCADA

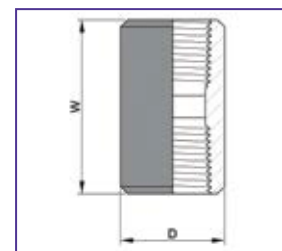
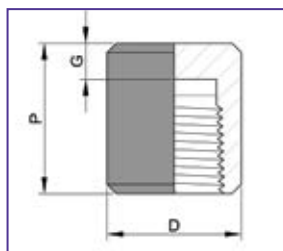

Diam Nominal	Cupla (W)	Tapa (P)		(D)		(G) Min.	
		3000 y 6000	3000	6000	3000	6000	3000
1/8"	32	39		16	22	5,0	
1/4"	35	25	27	19	25	5,0	6,5
3/8"	38	25	27	22	32	5,0	6,5
1/2"	48	32	33	29	38	6,5	8,0
3/4"	51	37	38	35	44	6,5	8,0
1"	60	41	43	44	57	9,5	11,0
1 1/4"	67	44	46	57	64	9,5	11,0
1 1/2"	79	44	48	64	76	11,0	12,5
2"	86	48	51	76	92	12,5	16,0
2 1/2"	92	60	64	92	108	16,0	19,0
3"	108	65	68	108	127	19,0	22,0
4"	121	68	75	140	159	22,0	28,5

Dimensiones en milímetros (mm)

TAPONES Y BUJES

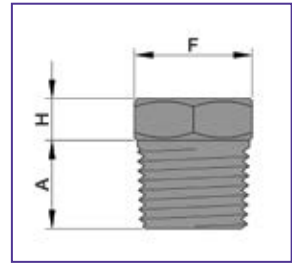
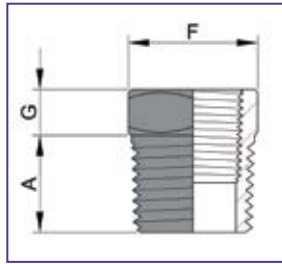

Diam Nominal	A (min.)	Tapon Cabeza Cuadrada		Tapon Cabeza Redonda		Tapon Cabeza Hexagonal y Buje Reduccion		
		B (min.)	C (min.)	E	D (Min.)	F	Altura del Hexagono (Min.)	
							Buje G	Tapon H
1/8"	9,5	6	7	10	35	11,0		6
1/4"	11	6	9,5	13	41	16,0	3	6
3/8"	12,5	8	11	17	41	17,5	4	8
1/2"	14,5	10	14,5	21	44	22,0	5	8
3/4"	16	11	16	27	44	27,0	6	10
1"	19	13	20,5	33	51	35,0	6	10
1 1/4"	20,5	14	24	43	51	44,5	7	14
1 1/2"	20,5	16	28,5	48	51	51,0	8	16
2"	22	17	33,5	60	64	63,5	9	17
2 1/2"	27	19	38	73	70	76,0	10	19
3"	28,5	21	43	89	70	89,0	10	21
4"	32	25	63,5	114	76	117,5	13	25

Dimensiones en milímetros (mm)

NIPLES Y ENTERROSCAS



Diam Nominal	A	
	Niple Reduccion	Enterreroscas
1/4"	57	39
3/8"	64	42
1/2"	70	46
3/4"	76	53
1"	89	55
1 1/4"	102	59
1 1/2"	114	63
2"	165	76
2 1/2"	178	85
3"	203	88
4"	229	93

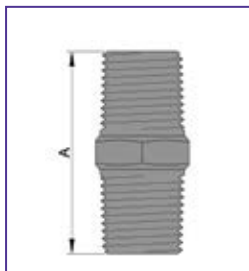
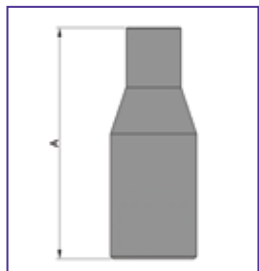
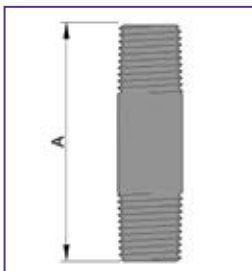

Dimensiones en milímetros (mm)

OTROS ACCESORIOS

• Inserto

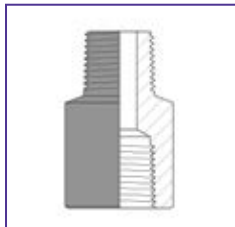

• Sokolet

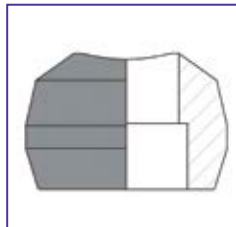

• Thredolet

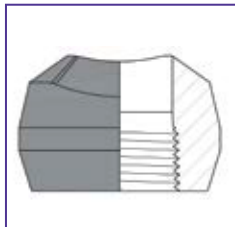

• Weldolet

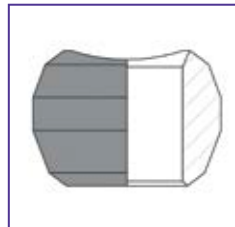

• Latrolet



COMO SOLICITAR LAS CONEXIONES FORJADAS

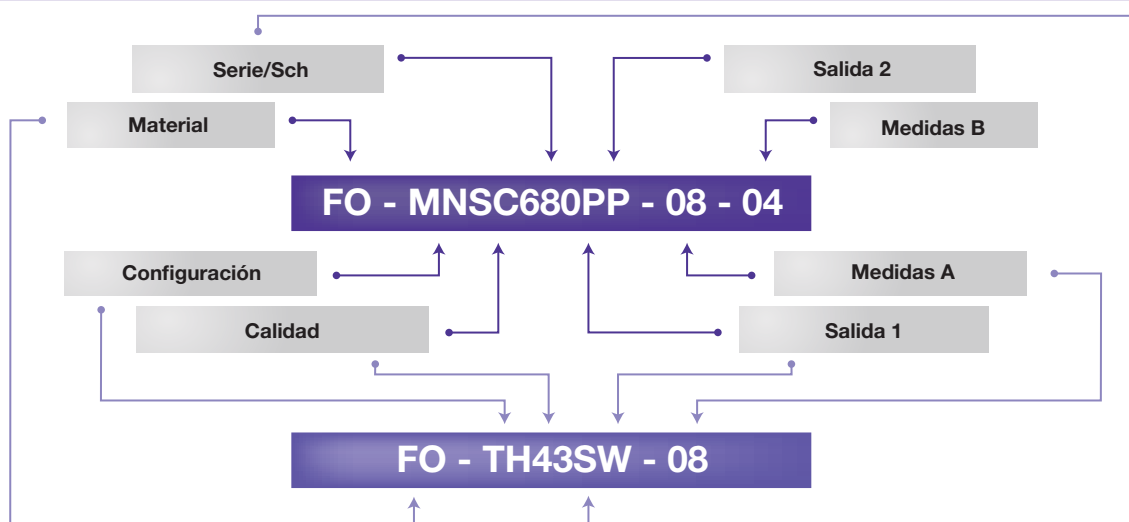

Material:

FO: Forjado Inoxidable
FC: Forjado Carbono

Configuración:

BR: Buje Reducción
TH: Te hembra
TM: Te macho
C9: Codo 90°
C45: Codo 45°
CR: Cruz
CPL: Cupla
CPPL: Cupla Reducción
MCPL: Media Cupla
RCT: Entrerroscas
SKT: Sockolet
TDT: Thredolet
WDT: Weldolet
TCH: Tapon Cabeza Hexagonal
TAP: Tapa
UD: Union Doble
IR: Inserto Reducción
SW: Swage
NSC: Niple Sin Costura
NSCR: Niple Sin Costura Reducción
MNSC: Medio Niple

Calidad:

4: AISI 304
6: AISI 316
10: AISI 310

Serie/Sch:

3: S. 3000 Lbs **X:** Sch XXS
6: S. 6000 Lbs **15:** S.150
9: S. 9000 Lbs **30:** S.300
10: Sch 10
40: Sch 40
80: Sch 80
160: Sch 160

Salida:

R: Roscado NPT
SW: Socket Weld
G: BSP
T: BSPT
P: Plano
1: Tipo 1
2: Tipo 2
3: Tipo 3

Salida 2:

R: Roscado NPT **T:** BSPT
SW: Socket Weld **P:** Plano
G: BSP

Medidas A:

02: 1/8"	24: 1-1/2"	128: 8"
04: 1/4"	32: 2"	160: 10"
06: 3/8"	40: 2-1/2"	192: 12"
08: 1/2"	48: 3"	224: 14"
12: 3/4"	64: 4"	256: 16"
16: 1"	80: 5"	288: 18"
20: 1-1/4"	96: 6"	320: 20"

Medidas B:

02: 1/8"	40: 2-1/2"	256: 16"
04: 1/4"	48: 3"	288: 18"
06: 3/8"	64: 4"	320: 20"
08: 1/2"	80: 5"	
12: 3/4"	96: 6"	
16: 1"	128: 8"	
20: 1-1/4"	160: 10"	
24: 1-1/2"	192: 12"	
32: 2"	224: 14"	